

**Happy 22nd Anniversary**



**ADVANCED SCIENCES RESEARCH & DEVELOPMENT  
CORPORATION, INC.**

**Post Office Box 109  
Lakemont, Georgia 30552**

**Business Hours:**

**7:00 A.M. — 12:00 P.M.**

**1:00 P.M. — 3:00 P.M.**

**Eastern Standard Time**

**(404) 782-5347**



## HISTORY OF ELOPTIC ENERGY DETECTION

Development in an instrumented form dates from the basic discoveries of Dr. Albert Abrams of San Francisco just after the turn of the century. We owe these discoveries to a most unusual and fortunate combination of circumstances: First, Abrams had had an exceptional medical training. After qualifying to receive a medical diploma in California before he was old enough, he learned German and graduated in medicine with the highest possible honors from Heidelberg University. Second, he had inherited great wealth and could afford to spend a long time doing post-graduate work in Heidelberg, Berlin, Paris, Vienna, and London, under the foremost researchers of the day. Later, his wealth allowed him to finance his own researches and contemptuously ignore those who accused him of using his discoveries to make money. Third, he became a pupil and later the friend of Hermann L. von Helmholtz, one of the great scientific figures of the time, who aroused his

interest in the burgeoning science of physics. This stimulated him to try to correlate the laws of biology with the laws of physics. Last - and perhaps most important - Abrams by nature was an exceptionally perceptive and persistent observer. Little escaped his trained observation and he counted no effort too great in trying to find the cause of some phenomenon he had noticed.

In 1910, while examining a patient with a cancerous ulcer on his lip, Abrams detected a small area of the abdomen which yielded a dull note under percussion with his fingers. After further tests he made the remarkable discovery that the dull note could only be detected when facing West. This suggested that he was dealing with a phenomenon, perhaps of an "electronic" nature which was influenced by the Earth's magnetic field.

This led the ever-ingenious Abrams to connect his patient with a wire to a healthy young man, and he made the further discovery that the cancerous "emanations" from the patient induced a dull note in the same area in the young man's abdomen. Later he found that the presence of the patient was unnecessary - a sample of his blood was sufficient to induce a reflex action in the abdominal muscles and to produce a dull note.

Convinced by now that he was on the track of something important which might help him to correlate the laws of biology and medicine, he made test after test, using patients who were suffering from a variety of diseases. He found that each disease yielded a dull note in one specific area of the abdomen; and he thought that he had found a new tool for diagnosis until he observed that samples from syphilitic patients yielded dull notes in the same area as a sample from cancerous patients.

Undaunted - and believing that the "emanations" from diseased blood were electronic - he introduced a variable resistance box into the circuit. By varying the resistance, he found he could "tune out" different diseases and could assign to each a value of ohms. He names his discovery "the electronic reactions of Abrams" or "E.R.A." and had one of the finest instrument makers of those days make most accurate resistance-boxes. For many years these were used by Abrams and his pupils in the diagnosis of diseases.

Some of his pupils found the art of percussing the surface of the abdomen difficult to acquire. For them Abrams found an alternative method: stroking the surface of the abdomen with a glass rod. When the emanations produced a reflex in the muscles under the skin, the rod would encounter resistance and the skin would tend to pucker.

Early in his experiments it occurred to Abrams to try to find the effects of well-known antidotes for certain diseases. When, for example, he put a sample of quinine into his apparatus along with a specimen of malarial blood, he made another basic discovery; the radiations from the quinine neutralized the radiations from the malarial blood and eliminated the dull note. This led him to apply E.R.A. to the treatment of disease. With the aid of one of the foremost radio experts of the time, Abrams devised an instrument he called the "oscilloclast." This was connected to the patient by a wire and electrode and produced intermittent negative potentials and radio frequencies. In circuit was a resistance box tuned to the value in ohms of the specific for the disease, which he had determined with his diagnostic instrument. Abrams and his pupils had great success in treating patients with the oscilloclast and the instrument was in use for many years.

With tireless energy, Abrams worked on his discoveries up to the night before his sudden death in 1924. He made many discoveries, the significance of which have yet to be fully explored. But, despite vast expenditures of time and money, he was never able to find an effective substitute for the human mind and body as a detector. Though substitutes for the abdomen have been found and are in use today, in every case the human mind and nervous system are essential.

Fortunately, imaginative doctors from all over the world came to San Francisco to take post graduate courses in E.R.A. Thus, Abrams' influence extended far beyond his own clinic and others were inspired to follow in his footsteps. Some of them have made great contributions to the development of what has come to be called Radionics. But the present science owes its origin to the basic discoveries described above, which might never have been made but for the exceptionally perceptive genius of Albert Abrams.

Most of the medical doctors who had taken Abrams' courses were so successful in diagnosis and treatment and so

busy with grateful patients that they had little time or inclination to do much research. But the publicity given to the "Electronic Reactions of Abrams" had excited the interest of imaginative people outside the medical profession and had encouraged them to experiment for themselves.

Radionics owes its next great impetus to a pioneer of radio, Thomas Galen Hieronymus, formerly of Kansas City, who produced some ingenious instruments which used vacuum tubes for "amplification" and condensers, instead of resistances, for "tuning". To Hieronymus belongs the honor of being awarded one of the most unusual patents ever granted by the United States Patent Office. This patent - No. 2,482,773 granted in 1949 - describes an instrument for the 'detection of emanations from materials and measurement of the volumes thereof.' As a detector, it used a rubbing-plate, which, by this time, many were using instead of a human abdomen. When the plate is stroked, the fingers encounter tactile resistance or "a stick" when the emanation is tuned in.

Excerpt from:

RADIONICS: A Science for the New Age

By: Edward W. Russell

## COSMICULTURE - THE NEW AGE AGRICULTURE

By: Dr. T. Galen Hieronymus

Let us begin our appraisal of the new System of Agriculture we call Cosmiculture with this very suitable quotation by Appolo Astronaut, Edgar C. Mitchell:

"There are no unnatural or supernatural phenomena; only very large gaps in our knowledge of what is natural. We should strive to fill those gaps of ignorance."

In our work for the last fifty-odd years, that is exactly what we have been doing! We have been pioneers in the exploration of subtle energies, in our attempt to fill the gaps in what is known about the higher, finer energies of matter and energy, outside the Electro-Magnetic Spectrum. We feel that so far we have been successful in our quest for knowledge, but we know there is still much to learn. In the nineteen-thirties, I did a successful experiment in an effort to learn if solar energy could be conducted over wires. When I found that it could, I realized what a tremendous sea of energy we on this planet are living in!

At that time we had not yet entered the Chemical Era in which we live today. Then there were no toxic chemical Pesticides and Herbicides, no sodium type commercial fertilizers. It is only since the Vietnam War that the nerve destroying toxic chemicals developed for chemical warfare have been recommended to the American Farmer for the purposes of killing insect pests and destroying weeds.

It is only lately that exorbitant prices for inadequate commercial fertilizers and all the modern medicines designed for livestock have made paupers of free-spirited farmers of this nation and other nations, wherever these Chemical-farming methods have been exported. Several years ago, as I saw the plight of the producers of the food of our nation, I got out my 1930 experiments and began seeking ways and means of using the sea of Free Energy all around us. The result of this experimentation is "The Cosmic Pipe" and our new method of farming we call "Cosmiculture".

First of all, the Rules of Eloptic or Subtle energy, apply to all phases of life on this planet, including the minerals and soil of the Planet. Everything is emanating energy, since all things are made of crystallized energy.

It is generally accepted that the Atom is the building block of Nature. As Dr. Rudolph Steiner, the great pioneer of Bio-Agriculture wrote and taught, "the natural methods are the best methods. The natural energies provided by nature are the greatest remedies."

We have all around us, as Dr. Steiner reminded us in his lectures on Agriculture, a great sea of energy: cosmic energy, solar energy, lunar energy, planetary system energy from the planets of our solar system and the planetary energy or the Eloptic Energy of our planet Earth itself. Without sunlight or the solar energy, there would be no photosynthesis, and no full growth of plants; Ergo, no harvests. The other energies are more subtle, but necessary, nevertheless. We also have so much electromagnetic and sonic energy in the atmosphere today that the Federal Government has been considering limiting the number of radio and television stations licensed in the future, because of our present level of electronic and sonic smog.

All this is energy: free energy, which we found may be tapped and conducted over wires. We have been building and testing our Cosmic Pipe for the purpose of carrying these cosmic energies from space down into the soil to be used for the redemption of the farming land from the load of poisons the chemical means of agriculture has imposed upon it, and balancing the soil content.

In order to fulfill our quest for free energy for the farmer, and as a means of cleansing his land from poisons and growing healthy stock and crops, we have had to understand the situation of this planet orbiting in a sea of energies. We had to learn about methods of bringing the energies from the areas mentioned by Dr. Steiner, into practical contact with the earth and the roots of plants. We already had the results of our experiments for over fifty years, our Eloptic Energy Analyzer and Treatment Analyzers. The use of one of our Eloptic Energy Instruments will give the farmer a means of analyzing and treating poisons out of feed for stock, of eliminating insect pests by treating plants and at the same time raise the vitality of plants. Use of a "Genuine Hieronymus" Analyzer gives the farmer a wholistic method of analyzing and treating sick stock, improving the health of flocks, treating fields for improved yields, etc. with the energies of finer media. We trust at

the same time consciousness is being expanded so that we may all gain a little more understanding of these energies.

The "impossibility of the impossible" is no longer a true hypothesis as we discover more and more about the nature of energy and the various forms and distinctive categories of energies. All the results of our research of the past is becoming more and more credible today, in the light of what is becoming accepted by scientists and manifested in the everyday working world in which we live. So we combine the "Genuine Hieronymus" Eloptic Energy Analyzer and our proved methods of working with it for best results, with our new Cosmic Pipe, for the achievement of that type of Agriculture we call "Cosmiculture". We are now prepared with the "Genuine Hieronymus" Eloptic Energy Analyzer and Treatment Instrument and the Cosmic Pipe, to use the finer media energies for the benefit of mankind.

When the Cosmic Pipe has been installed, it is gathering "Cosmic" energies of space into its head, from the air, putting them down a conductor through a resonance chamber to a modulating well, where we place whatever we wish to modulate the energy with, and then it goes on down into the amplifier-radiator in the pipe, set at least two feet deep in the ground. There the modulated energies are broadcast horizontally in a broad band out through the soil to the roots of the plants. The results have been tremendous. For many years we have seen soil being treated with soil nutrients and the use of organic methods of culture show peaks and valleys of soil nutrient deficiencies. In the six years of testing Cosmiculture we have seen soil come into full balance in six months without the addition of tons of nutrients. Harvests have been doubled, the time of production shortened by two weeks to a month and the natural sugar content of fruits, melons and berries has been markedly increased. Hay crops have been tripled, with heavier bales.

Tests we have done in the evaluation of methods of gathering energy with the pipe have proved that large amounts of copper or aluminum used in some manufactured devices are extremely detrimental to people and cattle as well as plants, so I have eliminated aluminum in the pipe and held copper to the barest minimum possible. We have found that huge amounts of copper radiated into the ground



through the soil have thrown the iron-copper balance out of harmony, decreasing the amount of iron in the soil and increasing the amount of copper beyond the needs of plants.

The Pipe also has had some effect on the weather in the areas where we have these installed, in fifteen different states. In our own vicinity, we have noticed that we no longer have violent weather and storms. The rain is gentle and falls often. Temperatures have been mild, compared with temperature before we installed the big pipe in our land.

We teach the farmer Cosmiculture with the Cosmic Pipes, to bring energy into the various fields and to modulate the soil with the Reagents needed by the soil, and with the "Genuine Hieronymus Eloptic Energy Analyzer and Treatment Instrument. We now can define this as a Wholistic method of agriculture which includes use of Natural Cosmic energies for the soil balance and rejuvenation, the use of the Analyzer and Treatment Unit to balance animal and poultry digestive systems, analyze the animals needs, analyze soils and organics, analyze and treat out water pollutions and take care of insect pests. We show you how to graph your data so that you can read and understand the balances and imbalances in you soil, crops, seed and plants.

In this manner, with the tools of Cosmiculture, you can have a definite work-plan, based on definite (not guessed at) evaluation of each field's individual needs, the health and food needs of your animals and chickens and turkeys and a means of correcting such health problems that have resulted from long time feeding of poisoned feedstuffs. We teach you to eliminate the costly guessing techniques now in practice among the "orthodox" farming methods, allowing you to avoid expensive duplication in plant and animal food and health programs. Thus you are able to individually monitor with the "Genuine Hieronymus" Eloptic Energy Analyzer and Treatment Instrument, the problem areas and know for sure just where help is needed and give the help needed immediately. You can take care of pollution problems and eliminate expensive pesticides and fertilizers. At the same time, your Cosmic Pipe equipment is balancing and harmonizing you soil, with free energies of Cosmic strength and power, resulting in soil balance, rejuvenation of soil, enrichment of soil, revitalization of soil and harmonizing of soil. This treatment of the soil results in earlier

fruition, increased yield, higher quality, nutritious crops, healthier stock, greater profits, elimination of pesticides and reduction in the use of fertilizers. The quality of the food you produce will be greatly improved. The net result, of course, is more money in you own pocket; a reward for your labor and the satisfaction that is every farmer's birthright: Satisfaction with your work and it's rewards and Joy in living a harmonious life.

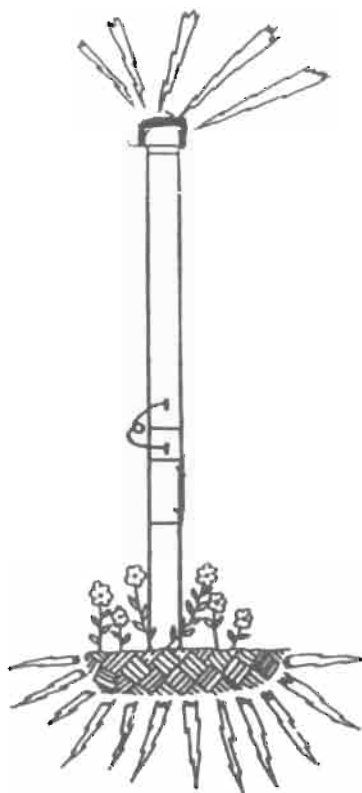

## CONDUCTING CHLOROPHYLL ENERGY OVER WIRES

About 1930, I decided to try an experiment of conducting Chlorophyll Energy over wires. I had been conducting Eloptic Energy over long distance via wire.

A wood platform was installed on the south side of the house about six feet above the ground in order to get the desired potential of energy which increases with distance above the ground.

Having some wooden cigar boxes available, I cut boxes apart and cut pieces and made eight boxes that were 2" x 2" x 4" although any size boxes will work.

Aluminum foil was placed on the bottom of seven boxes inside so as to be in contact with the soil. Similar pieces of foil were placed on the under side of the lid of each box. Wires were connected to each piece of foil, the wires from the lids were extended to the sun plates, the wires from the bottom foils were connected to the water pipe and thus grounded. See Figure #2 for details of the box construction.

Refer to Figure #1 which shows a "side" view of the installation. Figure #3 shows the system of connections.

Seven plates were placed on the platform so as to pick up energy from the sun and a wire was connected to each plate and extended down into the basement, each box having the top foil plate connected via wire to a plate out on the platform in the sunlight. The eighth box had no connection to the outside, it being the "control".

The plates on the platform were all different in size. The smallest was 2" x 4", the next 4" x 8", the largest was about 8" x 10" and one plate was copper screen wire.

Some dirt was screened and 1/2 inch of dirt placed in each box. Oat seeds were selected, all of uniform size and planted in two rows of 5 seeds spaced in each row, the 1/2" of dirt was placed on top in the box. The same amount of water was added to each box as needed from day to day.

All of the seeds sprouted about the same time. Then we noticed that there was no chlorophyll in the 10 plants in the control box. All of the boxes connected to outside plates had plants with much chlorophyll.

We were quite surprised to note that the plants in boxes with large outside plates seemed to look as if they

had been subjected to heat. Apparently the large outside plates were bringing in an excess of energy compared with the effect of the small size outside plates.

Very soon, the plants grew too tall for the small amount of "head room" in the boxes so each box was equipped with a spacer to raise the top of each lid up about 3/4".

The boxes were placed on a shelf in the end of the basement where there was little light, with no windows at that end. Also, the shelf was kept dark by a board placed in front and another on top to exclude all light. The plants were dark all of the time except when they were examined by a flashlight.

A friend tried to duplicate the experiment, but did not follow all instructions. Their basement was only about 3 feet from basement floor to ground level outside. Instead of placing the outside plates above ground 6 feet, they laid on the ground, thus they did not have the potential difference between outside collector and inside boxes and the experiment was a failure. Also, there was a window near that let much light into where the boxes were placed.

Anyone who expects to duplicate an experiment should be sure they know all the factors and that they follow the instructions exactly without any substitution or change. And as to changes, if you are trying to get a special result and are trying out several methods or ideas, one of the cardinal points to doing good work is to make just one change at a time. Then you know just what the results are. If you make two changes and the result is a failure, you do not know but that one of the changes and the result is a failure, you do not know but that one of the changes may have been alright. (See Figures #1, 2, and 3 next page).

By: Dr. T. Galen Hieronymus

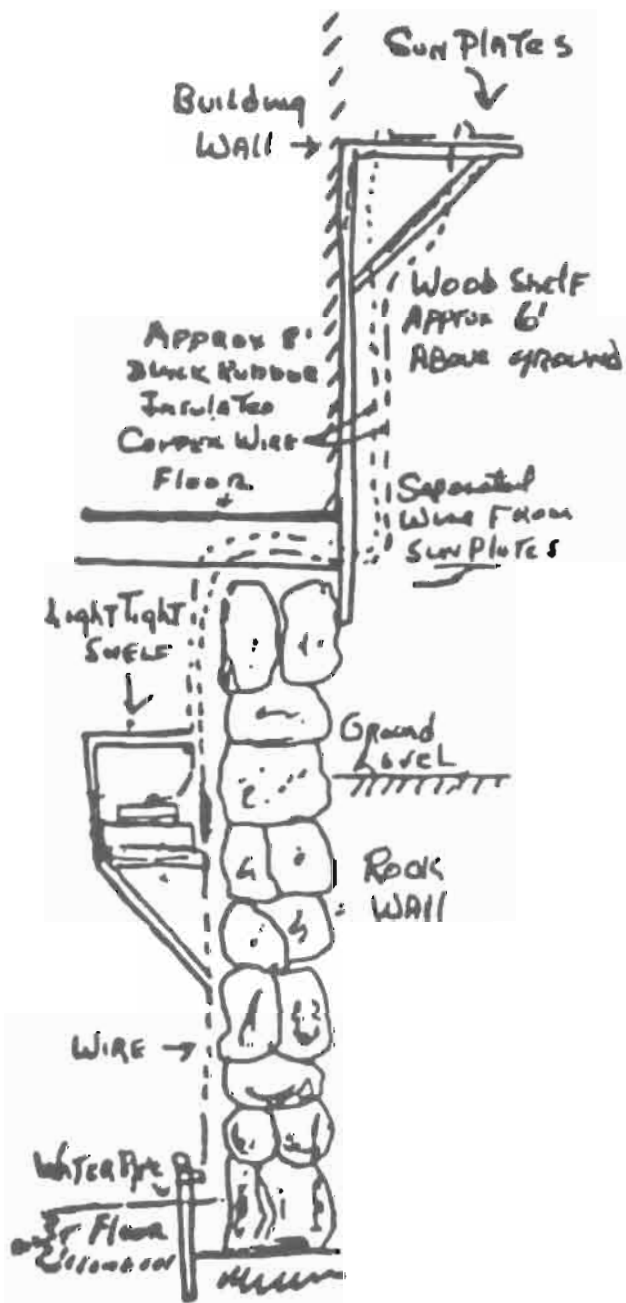
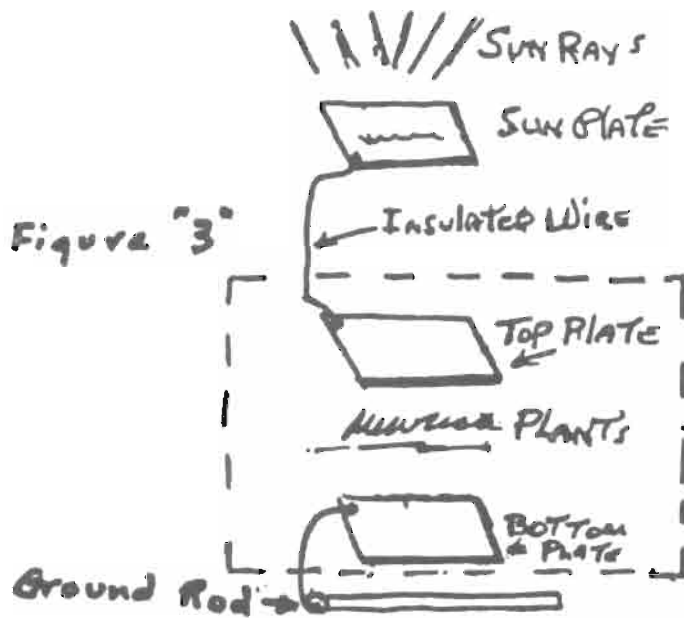
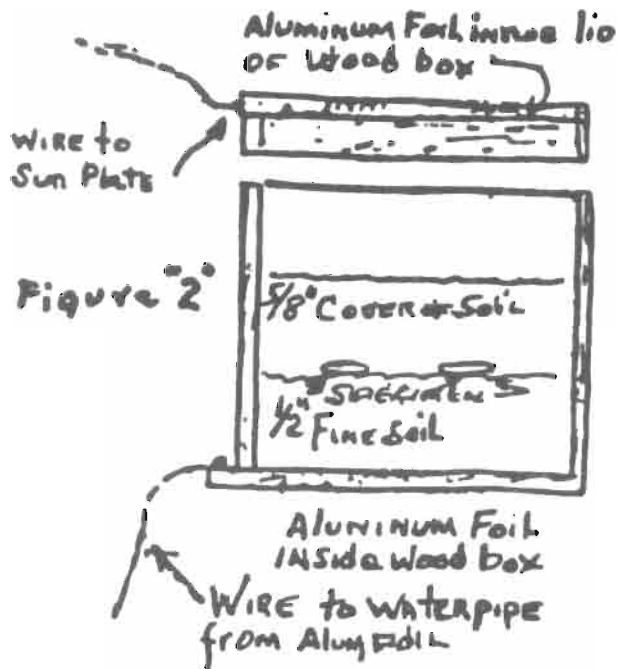

FIGURE "1"



## ADVANCED SCIENCES R&D CORPORATION

Our Corporation currently produces eight Eloptic Energy Instruments. These include: The Portable Analyzer/Treatment Unit, The Small Portable Analyzer Unit, The Reagent Beam Projector, The Specific Rate Beam Projector, The Anapathic Auto-Scan/Treatment Unit, The Homeopathic Preparator, and a Small, Medium, and Large Cosmic Pipe.

The Portable Analyzer/Treatment Unit can be used as both an analyzer and a treatment unit. The Small Portable Analyzer is used only for analysis.

The Reagent Beam Projector is used as a treatment unit with many purposes, from cleaning water to treating odors out of chicken houses, treating algae out of cattle watering tanks, and treating dampness out of hay, to name only a few. It can be used in conjunction with the Portable Analyzer/Treatment Unit for large projects. The Specific Rate Beam Projector works as a treatment unit as well, but it has the flexibility of utilizing both reagents and Eloptic Energy Rates to treat out negative energies.

The Anapathic Auto-Scan/Treatment Unit is an automatic instrument without a tactile sensor plate. The Homeopathic Preparator will charge a homeopathic preparation into a small or large container of distilled water, depending on the dosage required, as when homeopathic preparations are desired in quantity, such as for treating a herd of cattle.

The Cosmic Pipe is designed to balance the soil, with an abundance of solar and planetary energies picked up at the accumulator in the top of the pipe, modulated by energies needed by the plants, and broadcast underground into the soil to aid the plants in their transmutation of elements into what they feed upon. It is not necessary to use fertilizers when the pipe is used.

All of our instruments and pipes that we sell are sold with the purpose that they be used for experimental use in research to improve the quality of life and health of plants and animals. Being experimental in nature, it is not intended that they be used in violation of any Federal or State law that applies.



#### THE PORTABLE ELOPTIC ANALYZER/TREATMENT UNIT

This instrument is used to analyze, monitor, and positively manipulate Eloptic Energy.

It is used for animal and family needs, treating crop plants, raising the energy of fields and crops, soil testing, plant growth analyzing, treating animal and plant health, etc. This portable energy package includes: The Portable Eloptic Analyzer/Treatment Unit (which comes in its own case with lid for easy transport), Two books (The Eloptic Energy Manual and The Cosmiculture Manual), assorted Reagents, and a wall socket power supply. As with all of our instruments, it comes with a one year warranty against defects in manufacturing and workmanship.



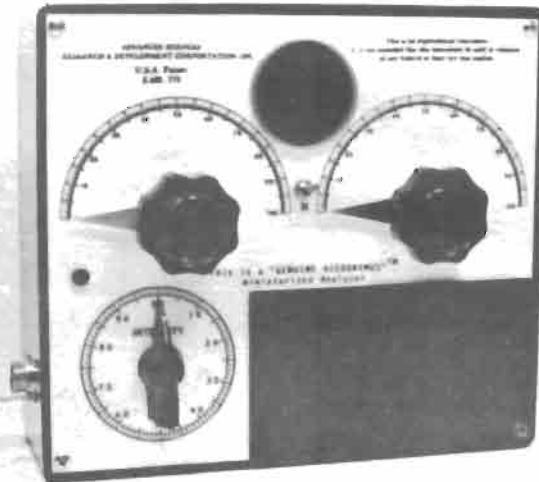

### THE SMALL PORTABLE ELOPTIC ANALYZER UNIT

This is a new instrument that we have recently developed in response to several requests for an individual analyzing unit.

It utilizes the analyzing components from our Portable Analyzer/Treatment Unit, but it does not contain any of the treating components. It is only used for analyzing. This instrument is very good for those of you who want to continuously monitor and analyze an ongoing project. It is also excellent when used with some of our other instruments and equipment such as our Beam Projectors or our Cosmic Pipes for various and assorted projects.

This package includes: The Small Portable Eloptic Analyzer Unit, a Small Rate Book, several test charts, and a wall socket power supply. This instrument also includes a one year warranty.



### THE REAGENT BEAM PROJECTOR

During the course of many years of research, we have found that some substances can be used in the treatment of plants or animals that hasten the results that we desire. We call these substances REAGENTS. This instrument utilizes the treatment capability of our other instruments with these Reagents to make a good treating device.

Just to list a few things that are now being done successfully on farms throughout the mid-west from Kansas, east thru Pennsylvania and New York, and even as far west as California: Beaming fertilizer to one's fields, Cleaning polluted wells, Making homeopathic sprays to foliar feed crops, Increasing moisture to crops in dry weather, as well as many other uses.

This package includes: The Reagent Beam Projector, a wall socket power supply, and a one year warranty.

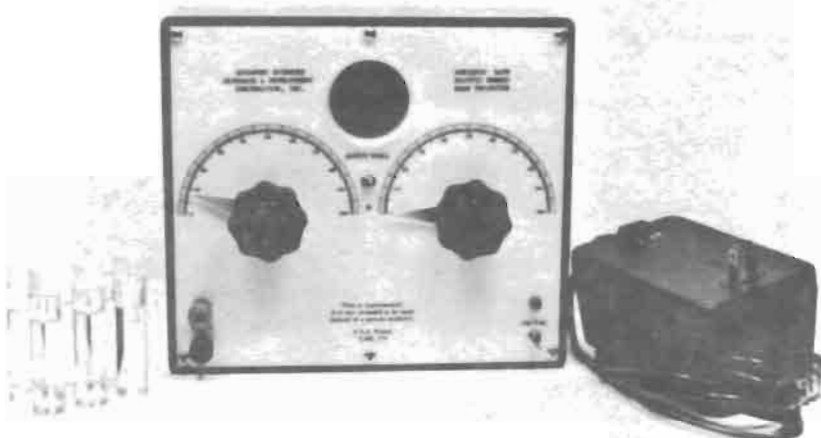

### THE SPECIFIC RATE BEAM PROJECTOR

This instrument utilizes the treating capability of the Portable Analyzer/Treatment and has the versatility of the Reagent Beam Projector. It can be used in much the same way as the Reagent Beam Projector, but it has the bonus of being able to treat on specific rates of Eloquent Energy to cancel out negative conditions, much the same way the Portable Analyzer/Treatment Unit works in treatment mode. It is great for using in conjunction with the Portable Analyzer/Treatment Unit if you have a project where you do not want to tie up your analyzing instrument while you are treating out a problem.

This package includes: The Specific Rate Beam Projector, a wall socket power supply, and a one year warranty.

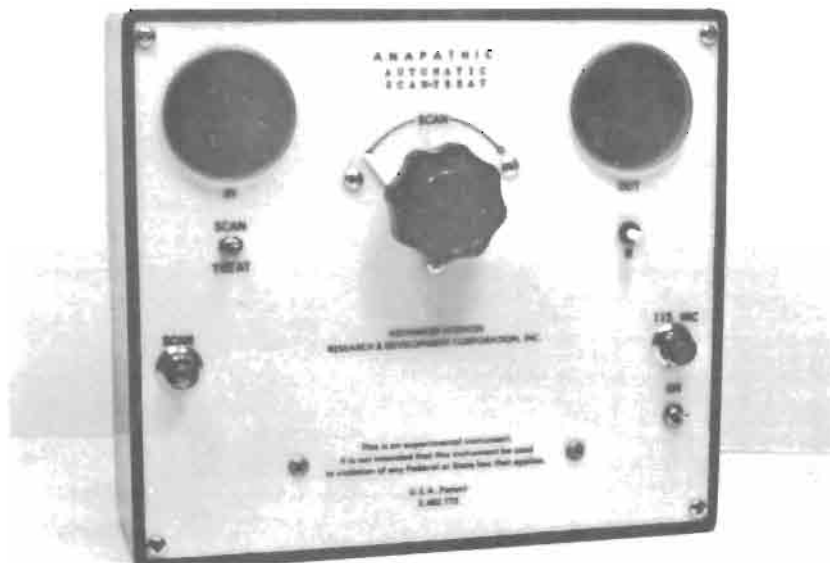

### THE ANAPATHIC AUTO-SCAN/TREATMENT UNIT

A proper prism can refract Eloptic radiations into their various frequencies. Eloptic radiations are radiated from the prism in a fan shape with a basic frequency from each tissue. By moving a "pick up" electrode along the arc of the quadrant involved, any one of these individual frequencies of Eloptic Radiations may be amplified and charged into a media such as water or milk. The "pick up" electrode is actuated by a motor mechanism and moves slowly along this arc taking only minutes to complete the trip.

The amplifier has the characteristic of amplifying each Eloptic ray to a certain maximum value. Strongly radiating tissues will thus be affected very little, but sluggishly radiating tissues will be given a greater boost. This produces a balance action which results in a normal relationship in the vitality of the various tissues - especially the glandular system. With patients who have multiple problems, this particular instrument is able to clear most of the toxic conditions of the body. Anything that is not cleared will be one major problem outstanding, which then is easy to work with, as the minor complications have been removed.

This package includes: The Anapathic Auto/Scan/Treatment Unit, a wall socket power supply, and a one year warranty.



### THE HOMEOPATHIC PREPARATOR

This instrument is another one of our new designs recently developed. It was developed in response to requests from those people who are working with large amounts of Homeopathic Preparations.

This instrument utilizes some of the technology that went into the development of the Reagent Beam Projector, but with the central design purpose being that of preparing Homeopathic Preparations. This instrument is very useful to those researchers who prepare large amounts of Homeopathic Preparations at one time.

This package includes: The Homeopathic Preparator, One Book, Two Kits of Homeopathic Remedies suitable for EXPERIMENTAL USE in treating, a wall socket power supply, and a one year warranty.

## THE COSMIC PIPE

The Cosmic Pipe is a self-driven broadcaster used directly in the field to stimulate biological transmutation and effect a balanced harmony in the soil, resulting in improved quality and quantity. When the Cosmic Pipe has been installed, it is gathering the "Cosmic" energies of space into its head, from at least six feet in the air, putting them down a conductor through a resonance chamber to a modulating well, where we place whatever we wish to modulate the energy with and then it goes deep into the ground. There, the modulated energies are broadcast horizontally in a broad band out through the soil to the roots of the plants. The results have been tremendous.

For many years, we have seen soil being treated with soil nutrients and the use of organic methods of culture show peaks and valleys of soil nutrient deficiencies. In the years of testing Cosmiculture, we have seen soil come into full balance in six months without the addition of tons of nutrients. Harvests have doubled, the time of production has been shortened by two weeks to a month and the natural sugar content of fruits, melons, and berries has been markedly increased.

The Cosmic Pipe is offered in three sizes: Small (up to 10 acres\*), Medium (up to 640 acres\*), and Large (up to 2500 acres\*).

\*Acreage may vary due to terrain. All of the Pipes come with instructions and Selected Farm Reagents.



**ADVANCED SCIENCES  
RESEARCH and DEVELOPMENT CORPORATION, Inc.**

Dr. T. Galen Hieronymus, Ph.D.  
President

Dr. Sarah E. Hieronymus, Ph.D.  
Secretary-Treasurer



P. O. Box 109  
Lakemont, Georgia 30552  
(404) 782-6347

RON SCHULTZ, Dealer  
Buxton, North Dakota

	Commercial Wheat \$50.00 per acre	Cosmiculture Wheat Pipe installed Jan. '85	Percent Increase
Seed Weight	Av. .36905 g/seed	Av. .4222 g/seed	+14.40%
Seed Head Count	42 @ 15.5g	45 @ 19.0g	7.14%
Seed Width	Av. 336.6mm	Av. 341.7mm	+ 1.52%
Range sm/lg	306/355 (49mm)	334/350mm (16mm)	
Stalk diameter.	205.5mm	Av. 247.5mm	+20.44%
Stalk Wall Thick- ness	27.5mm	37.5mm	+36.36%

COSMICULTURE ENERGY FEED ANALYSIS

	Energy	Digestability	Feed Assim.	Protein Content	Mineral Imbal.	Chemical Poison	Metallic Poison
Cosmi Wheat	786	595	738	485	73	52	64
#50 Fert. Wheat	436	210	394	205	67	54	77

	Protein	Bushel Weight	Yield	Sold**	Gross/Ac	Cost	Net/Ac
Cosmic Wheat	11%*	58#	50 bu/ac	\$2.14	\$107.00	\$ 2.00	\$105.00
Commercial Wheat	12.3%	59#	50 bu/ac	\$2.68	\$134.00	\$50.00	\$ 84.00

Note: \* Wet weather caused four-weeks delay in harvest.

\*\* Price based on 13% protein scale.

ILLINOIS DAIRY TEST

March 24, 1985	Soil Test from Map	Average 292.28
April 26, 1985	Installed "Cosmic Pipeline"	
May 14, 1985	Soil Test from Map	Average 637.0
May 31, 1985	Soil Test from Map	Average 687.14

<u>Date</u>	<u>Milk Record</u>	<u>Daily Production</u>	<u>Notes</u>
May 15, 1985	34.4/cow	2064.0 #	Cows on "old" feed this date.
" 16 "	34.6	2076.0 *60 cows	Cows started feeding Greenchops "new" feed.
" 17 "	36.3	2178.0	
" 18 "	36.3	2214.3	Added one cow
" 19 "	36.3	2214.3	
" 20 "	35.9	2189.9	
" 21 "	37.5	2287.5	Started feeding "new" Alfalfa Hay.
" 22 "	38.3	2336.3	
" 23 "	40.4	2464.4 *61 cows	
" 24 "	41.5	2531.5	
" 25 "	41.4	2525.4	
" 26 "	43.0	2623.0	
" 27 "	41.9	2555.9	
" 28 "	41.4	2525.4	
" 29 "	41.8	2508.0	
" 30 "	42.4	2544.0 *60 cows	
" 31 "	42.4	2586.4 - *61 cows	
		<u>40,508.5#</u>	

\* 27 of 61 cows are first-calf heifers.

	<u>Bacteria Count</u>	<u>Wisconsin Mastitis Test</u>
Dec.	68,000	12
Jan.	11,000	9
Feb.	22,000	15
Mar.	17,000	24
Apr.	15,000	20
May	2,000	10
June	79,000	-
July	1,000	-



ILLINOIS DAIRY TEST SUPPLEMENT

Gene Litweller, Dealer  
Phone (815) 389-2720

<u>Date</u>	<u>Pounds of Milk/Day</u>	<u>Income Increase</u>
April 26, 1985	Cosmic Pipeline Installed	
May 10, 1985	Approximate time of "Shed-down"	
" 15 "	-0-	-0-
" 16 "	12.0	1.56
" 17 "	114.0	14.82
" 18 "	150.0	19.50
" 19 "	150.0	19.50
" 20 "	125.9	16.37
" 21 "	223.5	29.05
" 22 "	272.3	35.40
" 23 "	400.4	52.05
" 24 "	467.5	60.78
" 25 "	461.4	59.98
" 26 "	559.0	72.67
" 27 "	491.9	63.95
" 28 "	461.4	59.98
" 29 "	444.0	57.72
" 30 "	480.0	62.40
" 31 "	522.4	67.91
		<u>\$ 693.64 TOTAL</u>

\*Note: Milk prices based on Average \$13.00 per cwt.

## THE INSTITUTE OF ADVANCED SCIENCES HOME STUDY COURSES

Our Home Study Course in Basic Development of Sensitivity is now available to students. This course is a prerequisite to all of the other courses that we offer except Science of Eloquent Energy.

Basic Development in Sensitivity covers the sensitizing of the senses used in everyday work and learning. In order to use present day Eloquent Energy equipment, hands and the sense of touch should be developed to be efficient. The exercises and practices outlined in this course are designed to do exactly that. There are twelve lessons and practice outlines in this course. For more information on this and other courses we offer, write to: Institute of Advanced Sciences, P.O. Box 109, Lakemont, GA 30552.

---

### ELOPTIC INFORMATION ENCYCLOPEDIAS

Advanced Sciences R&D is pleased to announce that it has for sale a set of Encyclopedias consisting of the following 11 books:

1. Dr. T.G. Hieronymus & Advanced Sciences Research and Development Corporation, Inc. ....\$25.00
  2. General Information .....\$15.00
  3. UKACO Project Information .....\$ 7.50
  4. English Radionics .....\$15.00  
Dr. Ruth Drown's Reprints (Radio Therapy)
  5. Volume #1 .....\$15.00
  6. Volume #2 .....\$15.00
  7. Volume #3 .....\$15.00
  8. Dr. Albert Abrams & Dr. Thomas Colson .....\$25.00
  9. Dr. J.W. Wigglesworth & The Pathoclast .....\$10.00
  10. Various Rates and Their Uses .....\$35.00
  11. Reprint: "The Secret of Life", By G. Lakhovsky ...\$15.00  
Reports Available
  12. Tracking The Astronauts In Appolo "11" .....\$10.00
- When placing an order, please order by the number as well as the title of the book.

## PUBLICATIONS OFFERED BY ADVANCED SCIENCES R&D

### THE ADVANCED SCIENCES ADVISORY

This publication is a 48 page Journal of Advanced Sciences Research and Development Corporation, Inc., with original papers on subtle energy devices, research and achievement.

If you would like to subscribe to our publication, please check the order form on the back page of this catalog and indicate for how long you would like a subscription (1 year, 2 years, etc.). This is a Bimonthly publication (6 issues/year) at a rate of \$20.00 per year.

If you would like a sample issue of the latest publication, please enclose \$2.50 to cover mailing and handling costs.

If you are interested in any of our back issues of the Advisory, please write us for a complete index of all our back issues. The price of back issues is \$3.50.

Write to: Advanced Sciences R&D, P.O. Box 109, Lakemont, GA 30552.

ADVANCED SCIENCES R&D ORDER FORM

NAME OF INSTRUMENT	QUANTITY	UNIT PRICE	TOTAL
1. Portable Analyzer/ Treatment Unit		\$1,500.00	
2. Small Portable Analyzer		\$750.00	
3. Reagent Beam Projector		\$750.00	
4. Specific rate Beam Projector		\$1,000.00	
5. Anapathic Auto-Scan/ Treatment Unit		\$2,000.00	
6. Homeopathic Preparator		\$750.00	
7. Small Cosmic Pipe		\$500.00	
8. Medium Cosmic Pipe		\$1,000.00	
9. Large Cosmic Pipe		\$1,250.00	
10. Rechargeable Battery Pack*		\$75.00	
11. Cigarette Lighter Power Adapter*		\$10.00	

\*Since all of our instruments (with the exception of our Cosmic Pipes) come with wall socket power supplies we offer these as alternatives for people who wish to work with our instruments in the field.

SUB-TOTAL  
PAGE ONE

ALL INSTRUMENT ORDERS ARE SHIPPED C.O.D. FOR THE FREIGHT AND INSURANCE CHARGES ONLY. PAYMENT MUST BE RECEIVED IN FULL BEFORE INSTRUMENTS WILL BE SHIPPED. PAYMENT MAY BE IN THE FORM OF PERSONAL CHECK, CASHIER'S CHECK, OR MONEY ORDER (NO CASH). CANADIAN ORDERS MUST BE ACCOMPANIED BY A CASHIER'S CHECK OR MONEY ORDERS. PERSONAL CANADIAN CHECKS NOT ACCEPTED.

Encyclopedias Ordered (Name, Number, Quantity)

\_\_\_\_\_  
\_\_\_\_\_  
SUB-TOTAL: \_\_\_\_\_

Publication Subscription- \_\_\_\_\_

(circle one) 1 2 3 years @ \$20.00/year: \_\_\_\_\_

Sample issue of latest publication @ \$3.50 each: \_\_\_\_\_

SUB-TOTAL: \_\_\_\_\_

PAGE TWO

GRAND TOTAL (ADD TOTALS FROM BOTH PAGES): \_\_\_\_\_

SHIPPING OR MAILING ADDRESS:

NAME: \_\_\_\_\_

ADDRESS: \_\_\_\_\_

CITY: \_\_\_\_\_

STATE: \_\_\_\_\_

ZIP CODE: \_\_\_\_\_

If you have any questions or problems, call us at:  
(404) 782-5347.